

FEATURES

- Complete 2-channel low noise programmable-gain preamplifier-ADC driver based on the THAT6261, THAT6263, or THAT6266 ICs
- Interchangeable modules for quick and easy performance evaluation and comparison for all three 626x gain step options
- Balanced microphone-level audio inputs on XLR connectors
- Balanced line inputs with -10 dB pad on TRS connectors
- Balanced ADC drive outputs on 3-pin headers
- General-purpose balanced outputs on XLR connectors
- Output filter can be configured to match most popular ADCs
- Easy to use PC Graphical User Interface software provides independent control of Gain, Enable, Mute, ZCD Modes, and GPO states. Channels may be linked for “stereo” gain control.
- Runs from bipolar ($\pm 5\text{ V}$) or unipolar ($+10\text{ V}$) power supplies
- On-board 3.3 V regulator for the digital logic supply
- On-board 5 V regulator for the ADC driver supply in unipolar operation
- Switchable phantom power (externally supplied $+48\text{V}$)
- VCM input for external ADC biasing

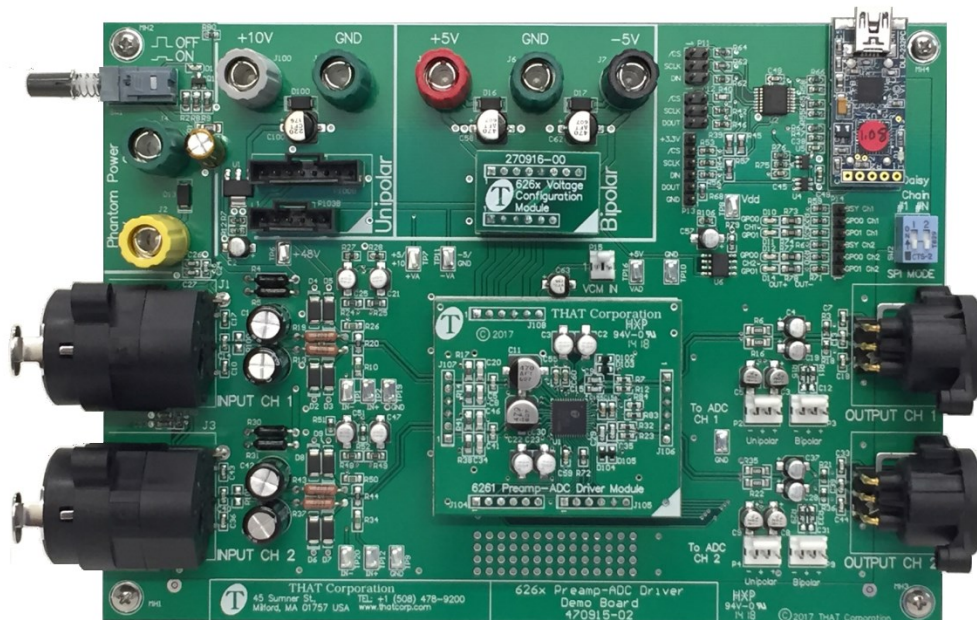
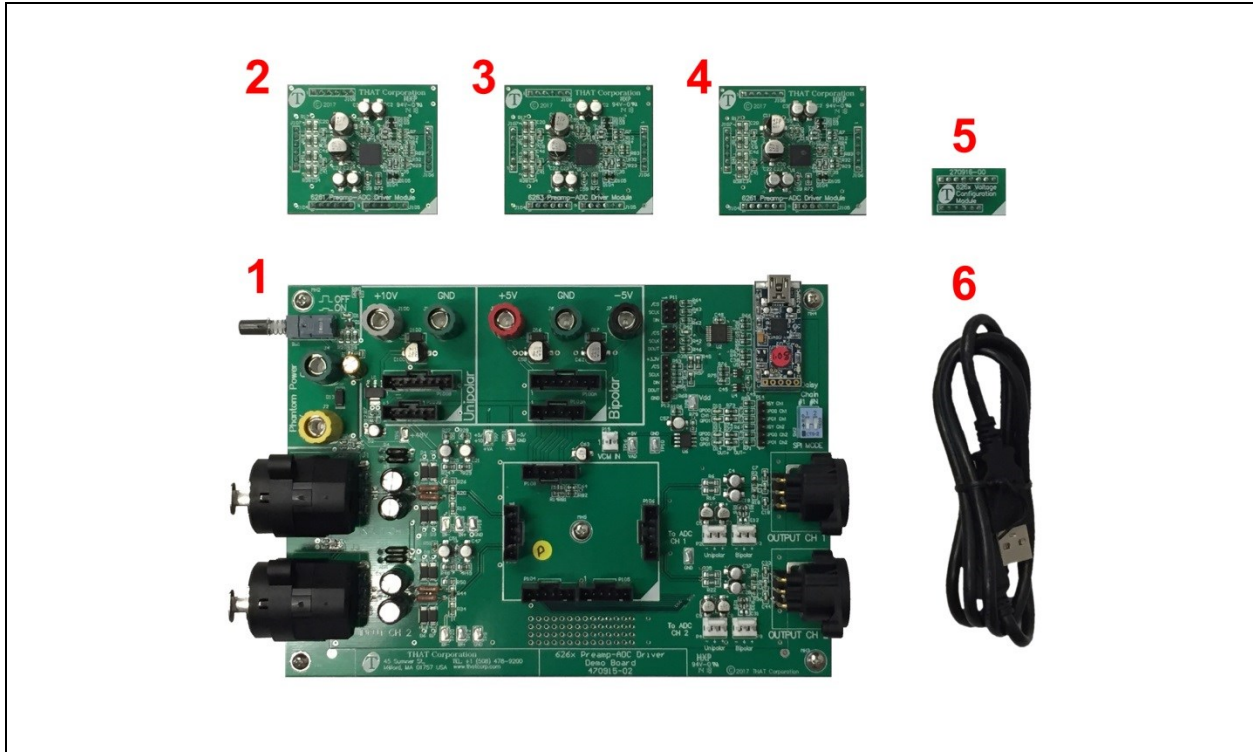

Figure 1. 626x Mother Board with the 6261 IC module installed and the unipolar/bipolar select module in the bipolar position.

Contents of your 626x Demonstration System



- | | |
|---|---|
| 1. 626x Demonstration Board Motherboard | 5. Unipolar/bipolar Voltage select module |
| 2. 6261 IC Module | 6. USB cable |
| 3. 6263 IC Module | 7. Marketing Materials (not shown) |
| 4. 6266 IC Module | 8. This data sheet (not shown) |

Unpacking and quick set-up

At a grounded workstation, carefully remove all the boards from their anti-static bags and inspect them for damage. Save the bags for future storage.

- Once satisfied with the kit contents, check that the Voltage Select Module is plugged into the appropriate socket for the power supply configuration (bipolar ± 5 V, or unipolar +10 V) that you will be using for your application. The demonstration system comes shipped with the module in the bipolar position. Please use care when removing or installing any of the modules. They are designed for a relatively tight fit. Gently rock the edges a bit if necessary and then pull or push while maintaining good alignment with the headers.

- Install the appropriate IC module (THAT 6261, THAT 6263, or THAT 6266) using the same caution noted above.

- Download the GUI (Graphical User Interface) software from the THAT Corporation website. The Software download is located on the “Demonstration Boards” page, or simply follow the link below:

http://www.thatcorp.com/Demonstration_Boards.shtml

- Connect the demo board to your computer via the supplied USB cable.

- Apply power to the demo board (± 5 V for bipolar operation, +10 V for unipolar operation) and start the GUI.

- Verify that the “SPI Mode” switches (SW2) are both in the OFF position (towards the bottom edge of the motherboard) and you are ready to go.

Important note concerning static discharge damage: the modules should be stored in their original anti-static bags when not in use on the Mother Board. Damage from static discharge during storage and handling is easily preventable by utilizing the supplied anti-static bags.

626x Demo Board Specifications^{1,2,3}

Parameter	Symbol	Typical	Units
Power Supply Voltage (bipolar mode) (unipolar mode)	V+ - V- V+, GND	± 5 +10	V
Power Supply Current (bipolar mode)	I(V+) I(V-)	0.25, both channels disabled 7, both channels enabled 25, both channels enabled, all LEDs on 0.25, both channels disabled 5, both channels enabled 5, both channels enabled, all LEDs on	mA
Power Supply Current (unipolar mode)	I(V+)	6, both channels disabled 13, both channels enabled 31, both channels enabled, all LEDs on	mA
Maximum Input Level - Mic Input (V+ /V- = ±5V, 0.15% THD)	V _{IN-BAL}	+16.5	dBu
Maximum Input Level - Line Input (V+ /V- = ±5V, 0.15% THD)	V _{IN, LINE INPUT}	+26.5	dBu
Gain (input to output)	A _{dB}	-8 to +34 (step size depends on variant)	dB
Gain error (all settings)	A _{err}	±0.3 (typical)	dB
Total Harmonic Distortion + Noise (f = 1 kHz; BW = 20 kHz)	THD+N	0.08 (-8dB gain, 2 V _{rms} Out) 0.0015 (+10dB gain, 2 V _{rms} Out) 0.003 (+34dB gain, 2 V _{rms} Out)	%
Equivalent Input Noise, Main Output (R _{SOURCE} =150 Ω, BW=20kHz)	EIN	-127.0 (+34dB gain) -118.5 (+10dB gain) -102.5 (-8dB gain)	dBu
Channel Separation (any combination of gain settings, R _{SOURCE} =150 Ω, BW=20kHz)		-110 (1 kHz) -92 (20 kHz)	dB
Frequency Response		± 0.5dB, 25Hz to 20kHz, Re:1kHz -1.5dB typical at 20Hz, +4dB gain -2.5 dB typical at 20 Hz, +34dB gain	

1. All specifications are subject to change without notice.
2. Unless otherwise specified, T_A=25°C, V_{A+}=+5V, V_{A-}=-5V, V_D=+3.3V, V_{AD}=+5V
3. Specifications listed are for the THAT6261 version. Specifications for the THAT6263 and THAT6266 demo board versions are very similar. See the THAT6261, THAT6263, and THAT6266 data sheets for full details.

Connections

Power

Bipolar vs. Unipolar Operation

The THAT626x family of parts have the ability to be powered from a bipolar supply (± 5 V typical) or from a unipolar supply (+10 V typical). In Unipolar mode, V_{ad} , the ADC driver supply, is generated from an on-board +5 V regulator. This capability allows the 626x to easily fit a variety of applications ranging from professional portable recorders to POE (Power over Ethernet) installations. While operation in either mode is straightforward, with very similar performance specifications, there are a few important differences that should be brought to your attention when considering the power supply options.

1) **Clamp Diodes:** The clamp diodes, (D102, D103, D104, and D105 on the IC Module) which are used to prevent exceeding the Common-Mode input range of the ADC driver, are only required for bipolar operation. These 4 diodes and the associated V_{clmp} voltage divider network are not required in unipolar mode and can be eliminated in the final product design. These diodes do no harm in unipolar mode and the demo board leaves them connected in both modes for simplicity.

2) **ADC Driver V_{cm} voltage:** The optimum ADC Driver VCM voltage required in order to insure that the driver can swing the full 2 V_{rms} is +2.5 V in bipolar mode and +3.1 V in unipolar mode. This voltage is automatically switched using the Voltage Select Module. The demonstration system provides both dc and ac coupled outputs on three pin headers for driving ADCs. We recommend using the dc outputs in bipolar mode and the ac outputs in unipolar mode. Please refer to the 626x data sheet for a detailed discussion concerning the optimum VCM operating conditions.

3) **Polarized capacitor orientation:** In unipolar mode, the 626x's inputs are biased at +5 V and the resulting bias across the input coupling capacitors (C13, C19, C32, and C42) changes polarity depending on the state of the phantom power switch. Also, the inter-stage coupling capacitors on the IC Module (C2, C3, C22, and C23) are biased in opposite directions depending on bipolar or unipolar operation. For this reason, you will notice that the aforementioned capacitors used in the demonstration system are of the Non-Polar (NP) type. In the case of C2, C3, C22 and C23 this was done for convenience and more cost effective fixed polarity capacitors can be used in your final design depending on the specifics of your application.

On Board Regulators and Phantom Power

The demonstration system requires a ± 5 V (± 5.5 V max) external power supply for bipolar mode operation or a single +10 V (+11.0 max) supply for unipolar operation. The on-board +5 V regulator is used in unipolar mode in order to provide +5 V required to power the ADC driver stage. The USB interface (U3)

runs on USB bus power, supplied by the host PC. An external +48 V phantom power supply can also be used for powering microphones if desired. Phantom power is activated by the switch SW1 and the associated LED will light up when active. Note, the LED will not light in either switch position if the external 48 V is not connected. The ground return for +48 V phantom power is via the chassis ground and connects to the Analog ground via the zero ohm resistor R80. The +5 V input (or the output of the internal 5 V regulator) is regulated on board to the 3.3 V required for the digital logic.

Audio Inputs

The Neutrik combo connector accepts an XLR or 1/4" TRS cable. The 1/4" TRS signal path includes a 10 dB pad in order to support line level inputs up to +26.5dBu. The input impedance is 3.02k at the XLR inputs and 10k looking in from the 1/4" inputs. Pads for an additional shunt resistor (R100 and R101) have been provided across the inputs in order to easily facilitate input impedance modifications.

ADC Driver Outputs

The demo board is assembled with the driver output configured in accordance with the filter configuration often recommended by the ADC manufactures. This includes a 90.9 ohm resistor inside the driver feedback loop (R7, R12, R23, and R32), located on the pre-amp/ADC module and a 680 pF feedback capacitor (C9, C15, C29, and C35), also located on the preamp/ ADC module. Pads have also been included on the mother board for the typically recommended 2.7nF shunt capacitor. This shunt capacitor should be located as close as possible to the actual ADC converter's input pins if using the 626x demonstration system to drive a converter for your test measurements. When using the demonstration system without a converter, the pads provide a convenient location for the capacitor when making filter measurements.

A zero ohm resistor (R11, R15, R29 and R33) has been placed in series with the 3-pin output headers on the motherboard in order to provide a convenient means for implementing alternate output filter configurations. There is also a prototyping area available on the board if more substantial output filtering modifications are required for your particular ADC. There are two 3-pin output headers on each channel, one is dc coupled for use in bipolar mode, while the other is ac coupled for use in the unipolar mode. Please note that the XLR output is ac coupled and has a 49.9 ohm series resistor for isolation. This XLR output is intended to drive your general purpose test equipment.

VCM IN

The demo board provides the option for biasing the ADC driver outputs directly from the ADC's common-mode reference voltage via the VCM IN header (P15). Please note that reference voltage available on most

ADCs has precious little current drive capability and it is highly recommended that an opamp buffer be used ahead of the VCM input in order to avoid problems associated with the current draw from the on-board VCM bias resistors.

USB

A PC must be plugged into the demo board via USB in order to control parameters in the 626x. Take care not to hot plug the demo board while the GUI software is running as this will sometimes crash the Windows drivers. If USB communication is interrupted or lost while the demo board is running, simply use the “Re-connect” command from the GUI panel to re-establish communication from the PC to the 626x.

General Purpose Outputs and Busy Signal Outputs

Each channel of the 626x provides two GPO outputs in addition to a digital busy signal (BSY). These pins are connected to header P14 via small series resistors. The GPOs are also connected directly to LEDs D10, D11, D12, and D14 using 330 Ω series resistors. The on-board LEDs provide a convenient means for quickly verifying connectivity when using the USB interface with our software GUI.

Connecting Multiple Demo Boards in Daisy Chain Mode

Headers P11 and P12 provide easy access to the SPI input and output signals for linking multiple sets 626x channels. Please refer to the 626x Data Sheet for complete details. Note that the on-board DIP switches SW2-1 and SW2-2 control the Daisy Chain function. These switches must be set to the OFF position (toward the bottom of the board) in order to insure proper operation when using the USB interface.

Software Set-up and Operation

Download the latest Demo Board GUI software from the THAT Corporation web site. Double click the MicPre.exe icon and the Digitally Controlled Mic Preamp Demo Board Selector will appear. Select the THAT626x from the drop-down menu.

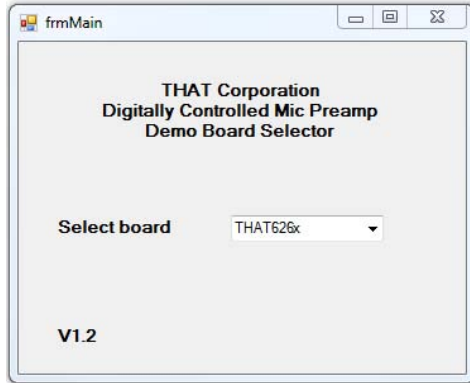

The 626x GUI should appear:

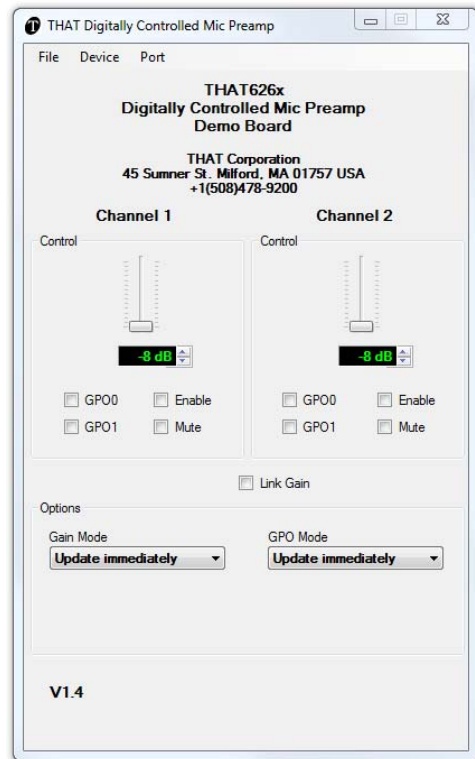

Next, select the appropriate 626x controller for your demo board, THAT6261, THAT6263, or THAT6266, from the Device drop-down menu depending on which module you have installed into the motherboard. Be sure to select the correct device; the structure of the software gain command word is different for each version of the part. The 626x will still operate safely if the wrong device is selected, but the device gain will not be as expected from the indication on the GUI.

If the GUI fails to recognize the demo board (most likely caused by a missing USB connection) you will see the following error message:

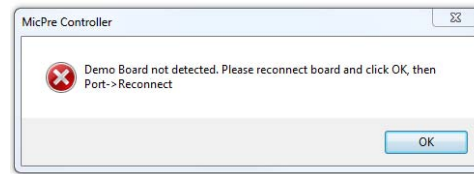

If this message appears, you can click OK and the GUI will open, but there will be no connection to the demo board. Once the source of the problem has been resolved (i.e. Turn on the power or connect the missing USB cable), use the Port=>Reconnect pull down to establish communications.

The Port=>Reconnect pull down can be used anytime to reestablish the USB link between the GUI and demo board.

Power-on Reset: The 626x's internal reset is initiated when the 3.3 V logic supply falls below about 0.6V. This 3.3 V logic supply is derived on the demo board from the +5 V supply via an on-board regulator. If the +5 V supply is removed, please insure that the 3.3 V on-board supply has enough time to discharge to below this 1.2 V reset threshold before re-applying the +5 V supply, otherwise the part may power up in an unspecified condition.

One final note; if the channel is not passing audio as expected, verify that the "enable" check box is selected, and that the "Mute" check box is NOT selected. Also, make sure that you have the correct device (6261, 6263, or 6266) selected from the "Device" drop-down menu.

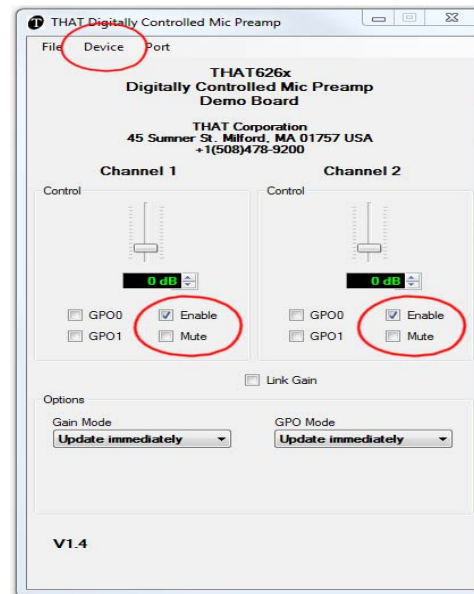

Appendix A. Schematic (1 of 5)

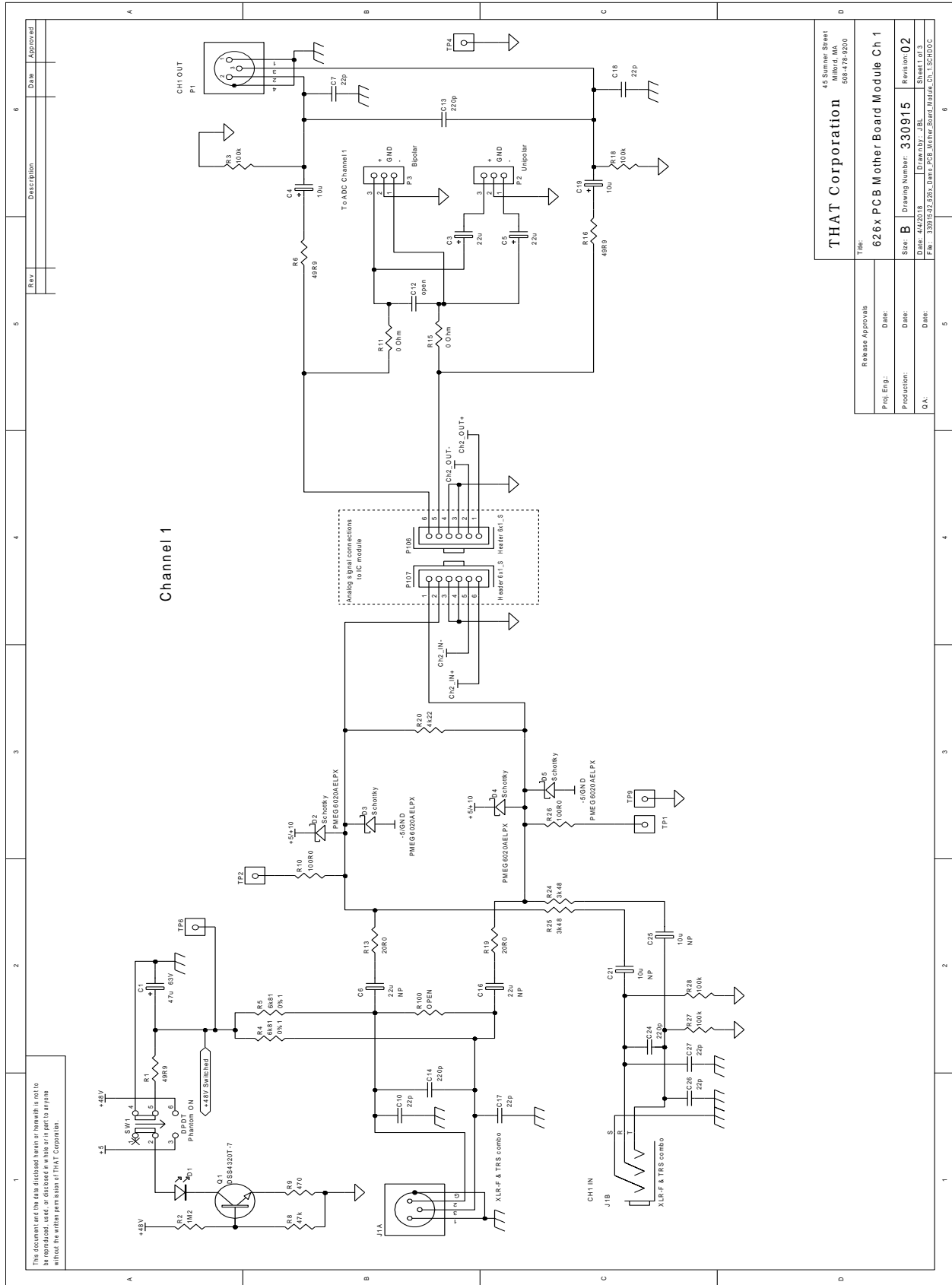

Appendix A. Schematic (2 of 5)

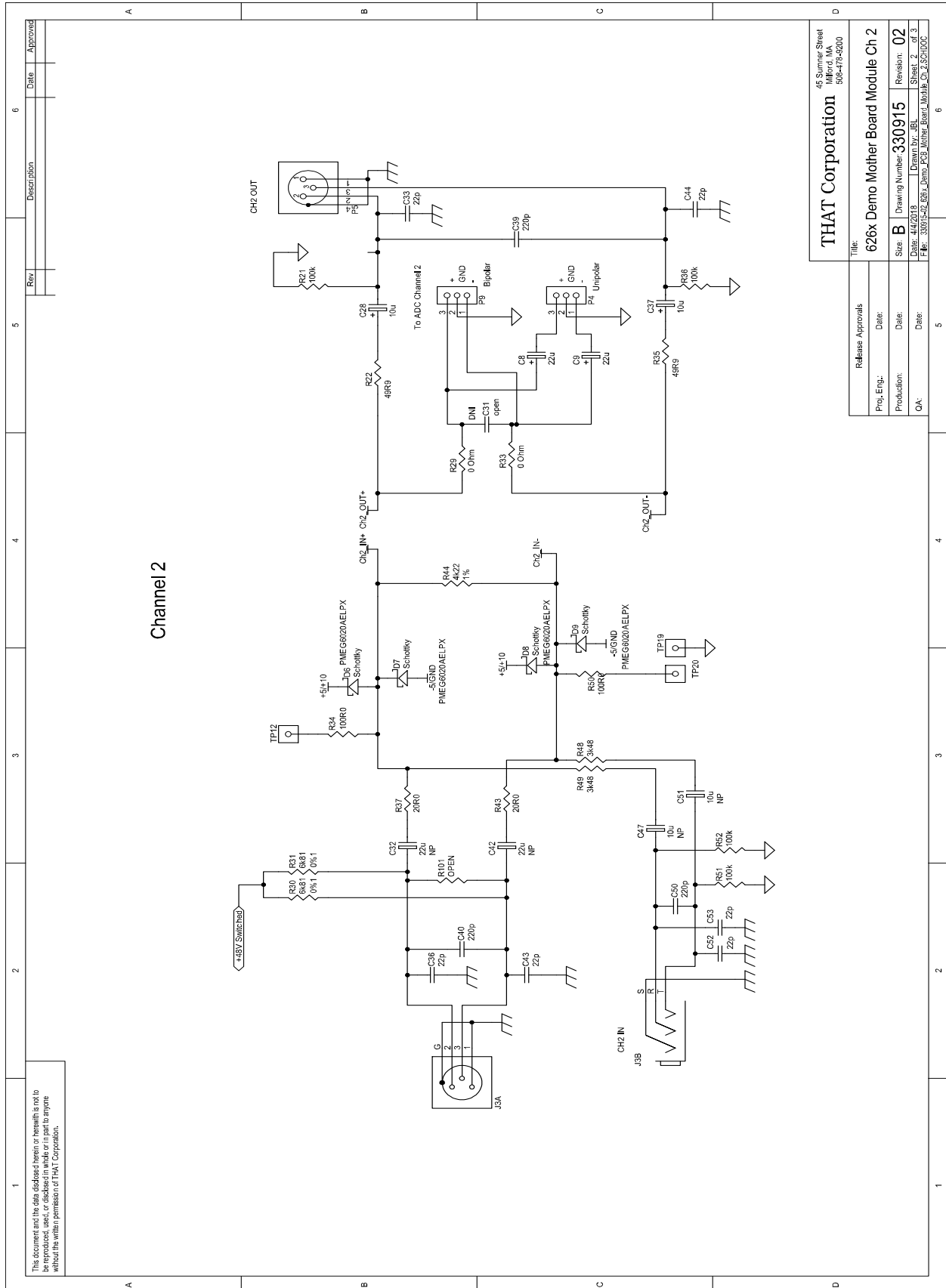

This document and the data disclosed herein or herewith is not to be reproduced, used, or disclosed in whole or in part to anyone without the written permission of THAT Corporation.

THAT Corporation		45 Sumner Street Milford, MA 508-478-9200	
Title: 626x Demo Mother Board Module Ch 2			
Release Approvals	Date:	Proj. Eng.:	Date:
Size: B		Drawing Number: 330915	
Production:		Revision: 02	
Date: 4/22/15	Drawn by: JBN	Date:	Sheet 2 of 3
Rev: 30312-626x Demo Board Module Ch 2 3/25/15	QA:	Date:	

Appendix A. Schematic (3 of 5)

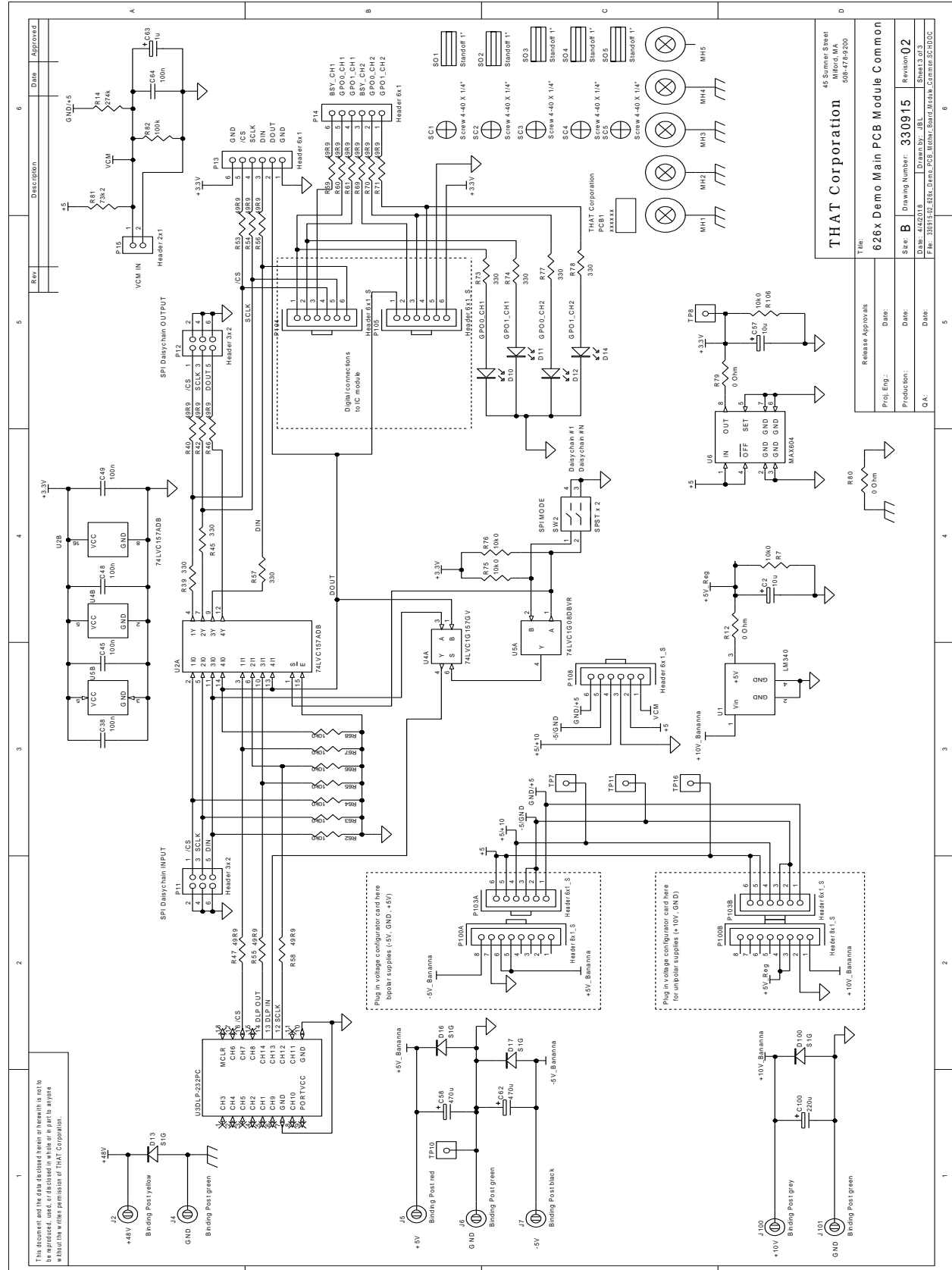

This document and the data disclosed herein or hereinto is not to be reproduced, used, or disclosed in whole or in part to anyone without the written permission of THAT Corporation.

Appendix A. Schematic (4 of 5)

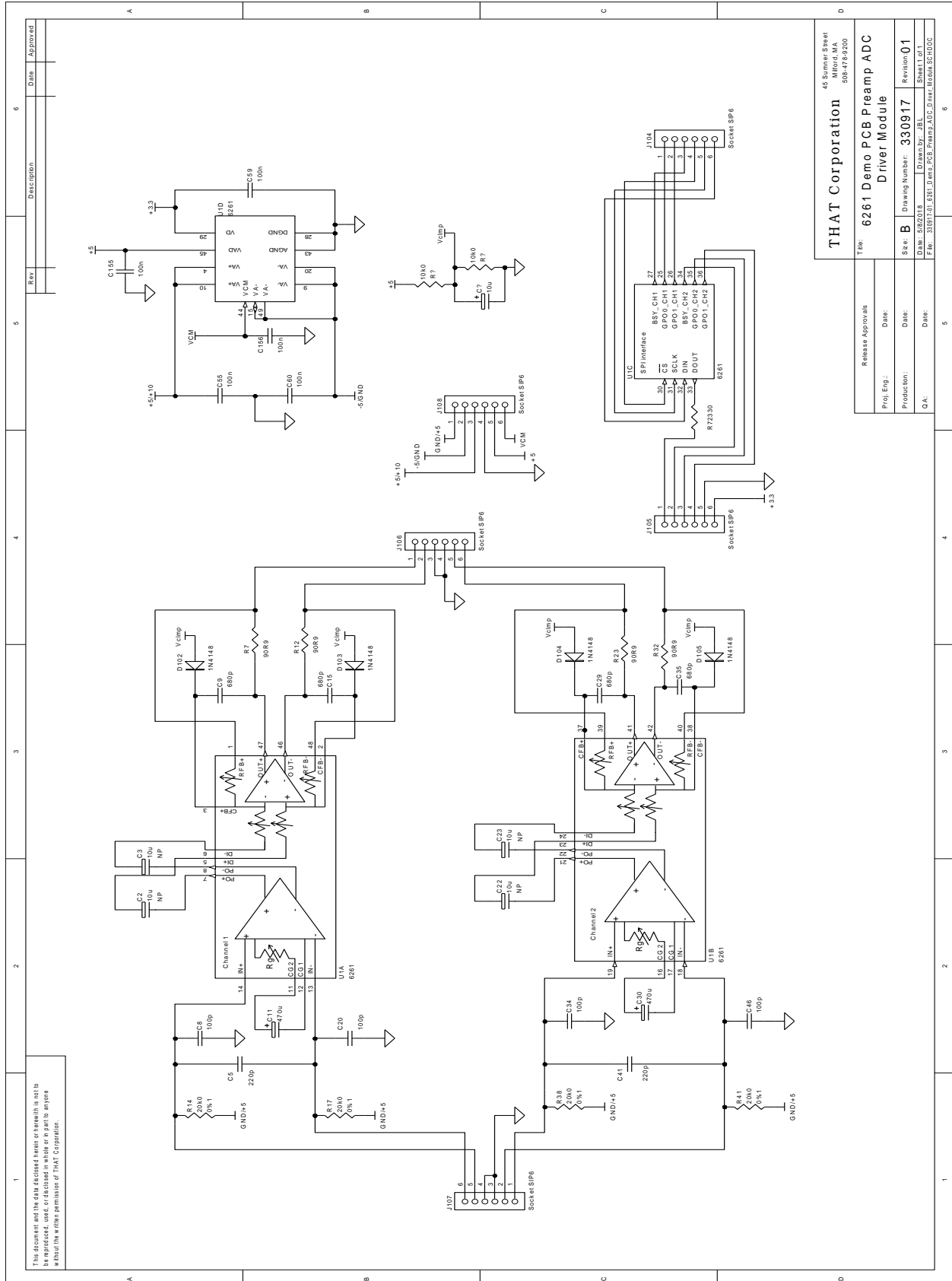

Appendix A. Schematic (5 of 5)

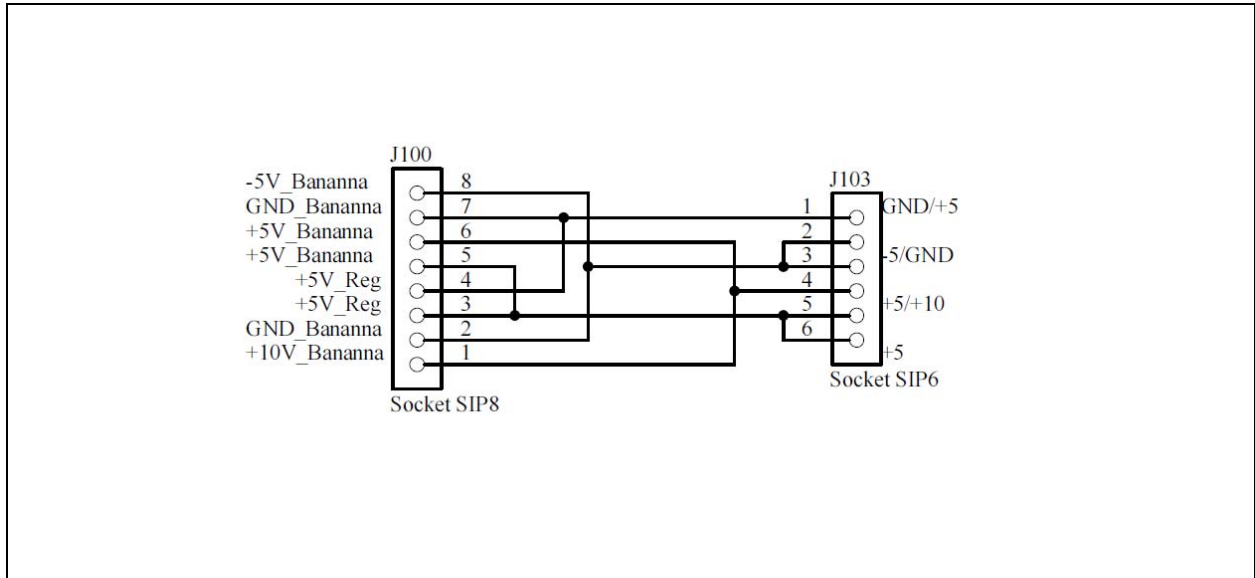

Schematic Diagram, unipolar/ bipolar Voltage Select Module

Appendix B. Bill of Materials – 626x-DEMO Motherboard

Item #	Description	Quantity	Designator	Manufacturer	Mfr P/N
1	Cap 47uF 63V 20% Aluminum Radial	1	C1	Nichicon	UFW1J470MED
2	Cap 10u 25V 20% Aluminum SMD 4.3x4.3	6	C2, C4, C19, C28, C37, C57	United Chemi-Con	EMVA250ADA100MD55G
3	Cap 22u 10V 20% Aluminum SMD 4.3x4.3	4	C3, C5, C8, C9	Panasonic	EEE-1AA220WR
4	Cap 22uF 63V NP 20% Aluminum Radial 8mm	4	C6, C16, C32, C42	Nichicon	UVP1J220MPD
5	Cap 22p 50V 5% NPO Ceramic SMD 0603	12	C7, C10, C17, C18, C26, C27, C33, C36, C43, C44, C52, C53	KEMET Corporation	C0603C220J5GAC
6	Cap 0603	2	C12, C31		
7	Cap 220p 50V 5% NPO Ceramic SMD 0603	6	C13, C14, C24, C39, C40, C50	TDK	C1608C0G1H221J
8	Cap 10u 10V NP 20% Aluminum SMD 4mm	4	C21, C25, C47, C51	Nichicon	UWP1A100MCL1GB
9	Cap 100nF 50V X7R Ceramic SMD 0603	5	C38, C45, C48, C49, C64	Murata Electronics	GRM188R71H104K
10	Cap 470uF 10V 20% aluminum SMD 6.3mm	2	C58, C62	Panasonic	EEE-FTA471XAP
11	Cap 1uF 20% 35V AL SMT Lo ESR	1	C63	Panasonic	EEE-FC1V1R0R
12	Cap 220uF 16V 20% aluminum SMD 6.3mm	1	C100	Panasonic	EEE-FT1C221AP
13	LED Red 0603	5	D1, D10, D11, D12, D14	OSRAM Opto Semiconductors	LS L29K-G1J2-1-Z
14	Diode Schottky 60V 2A SMD SOD128	8	D2, D3, D4, D5, D6, D7, D8, D9	Nexperia	PMEG6020AELPX
15	Diode S1G 1A 400V SMD DO-214AC (SMA)	4	D13, D16, D17, D100	Diodes, Inc.	S1G-13-F
16	3p female XLR & TRS chassis mount	2	J1, J3	Neutrik USA Inc.	NCJ6FI-H
17	5-Way Binding Post Chassis Mount Yellow	1	J2	Pomona Electronics	3760-4
18	5-Way Binding Post Chassis Mount Green	3	J4, J6, J101	Pomona Electronics	3760-5
19	5-Way Binding Post Chassis Mount Red	1	J5	Pomona Electronics	3760-2
20	5-Way Binding Post Chassis Mount Black	1	J7	Pomona Electronics	3760-0
21	5-Way Binding Post Chassis Mount Grey	1	J100	Pomona Electronics	3760-8
22	XLR-3C male right angle chassis mount	2	P1, P5	Neutrik USA Inc.	NC3MAH
23	Conn Header 3p Male Vert Locking 0.1 Tin	4	P2, P3, P4, P9	AMP	640456-3
24	Conn Header 3x2 6p Male Vert 0.1 Gold	2	P11, P12	3M	2306-6121TG
25	Conn Header 6p Male Vert 0.1 Gold	2	P13, P14	Molex	22-28-4063
26	Conn Header 2p Male Vert Locking 0.1 Tin	1	P15	AMP	640456-2
27	Conn Header Shrouded 8p Male Vert 0.1 Gold	2	P100A, P100B	Molex	70543-0007
28	Conn Header Shrouded 6p Male Vert 0.1 Gold	7	P103A, P103B, P104, P105, P106, P107, P108	Molex	70543-0005
29	Printed Circuit Board	1	PCB1	THAT Corporation	xxxxxx
30	Transistor DSS4320T NPN 20V 2A SOT-23	1	Q1	Diodes, Inc.	DSS4320T-7
31	Res 49R90 1% 0.25W Thick Film SMD 1206	5	R1, R6, R16, R22, R35	Panasonic	ERJ-8ENF49R9V
32	Res 1M2 1% 0.125W Thick Film SMD 0805	1	R2	Vishay Dale	CRCW08051M21FKEA
33	Res 100k 1% 100mW Thick Film 100ppm 0603	9	R3, R18, R21, R27, R28, R36, R51, R52, R82	Vishay Dale	CRCW0603100KFKEA
34	Res 6k81 0% 1 1/4W Metal Film 25ppm axial	4	R4, R5, R30, R31	IRC	RC55LF-D-6K81-B-B
35	Res 10k0 1% 0.1W Thick Film SMD 0603	11	R7, R62, R63, R64, R65, R66, R67, R68, R75, R76, R106	Vishay Dale	CRCW06031002FRT1
36	Res 47k0 1% 0.125W Thick Film SMD 0805	1	R8	Yageo	RC0805FR-0747KL
37	Res 470R 1% 0.125W Thick Film SMD 0805	1	R9	Yageo	RC0805FR-07470RL
38	Res 100R0 1% 100mW Thin Film 25ppm SMD 0805	4	R10, R26, R34, R50	KOA Speer Electronics	RN732ATTD1000F25
39	Res OR Thick Film SMT 0603	7	R11, R12, R15, R29, R33, R79, R80	Panasonic	ERJ-3GEY0R00V
40	Res 20R0 0% 1 100mW Metal Film Axial	4	R13, R19, R37, R43	Vishay Dale	RN55C20R0BB14
41	Res 274k 1% 0.1W	1	R14	Panasonic	ERJ-3EKF2743V
42	Res 4k22 1% 125mW Thin Film 100ppm SMD 0805	2	R20, R44	Yageo	RC0805FR-074K22L
43	Res 3k48 1% 0.125W Thick Film 100ppm SMD 0805	4	R24, R25, R48, R49	Panasonic	ERJ-6ENF3481V
44	Res 330R 1% 0.125W Thick Film SMD 0805	7	R39, R45, R57, R73, R74, R77, R78	Yageo	RC0805FR-07330RL
45	Res 49R9 1% 100mW Thick Film SMT 0603	15	R40, R42, R46, R47, R53, R54, R55, R56, R58, R59, R60, R61, R69, R70, R71	Vishay Dale	CRCW060349R9FKTA
46	Res 73.2k 1% 0.1W	1	R81	TE Connectivity	CPF0603F73K2C1
47	Res OPEN SMD 0805	2	R100, R101	Do Not Install	
48	Screw 4-40 X 1/4" PHILLIPS PAN HEAD SS	5	SC1, SC2, SC3, SC4, SC5	McMaster-Carr	91772A106
49	Standoff 4-40 X 1/4" X 1" HEX AL	5	SO1, SO2, SO3, SO4, SO5	RAF Electronic Hardware	2112-440-AL-7
50	Switch DPDT push-push action	1	SW1	E-Switch	PBH2UEENAGX
51	Switch SPST 2 sections Gold	1	SW2	CTS Electrocomponents	206-2
52	Test Point SMT 2.5 X 4.50	13	TP1, TP2, TP4, TP6, TP7, TP8, TP9, TP10, TP11, TP12, TP16, TP19, TP20	Keystone Electronics Corp.	5016
53	IC LM340 Volt Reg +5V SOT-223-4	1	U1	Texas Instruments	LM340MP-5.0/NOPB
54	IC 74LVC157 Quad 2-In Multiplexer 16SSOP	1	U2	NXP	74LVC157ADB,112
55	Module USB FT232R W/18F2410	1	U3	DLP Design, Inc	DLP-232PC
56	Single 2-Input Multiplexer	1	U4	Nexperia	74LVC1G157GV, 125
57	Single 2-Input AND Gate	1	U5	TI	SN74LVC1G08DBVR
58	IC MAX604 Volt Reg Adj 3.3V 0.5A 8SOIC	1	U6	Maxim / Dallas	MAX604CSA

Appendix B. Bill of Materials – 626x-DEMO IC Module

Item #	Description	Qty	Designator	Manufacturer	Mfr P/N
1	Cap 10u 10V NP 20% Aluminum SMD 4mm	4	C2, C3, C22, C23	Nichicon	UWP1A100MCL1GB
2	Cap 220p 50V 5% NPO Ceramic SMD 0603	2	C5, C41	TDK	C1608C0G1H221J
3	Cap 100p 50V 5% NPO Ceramic SMD 0805	4	C8, C20, C34, C46	Murata Electronics	GRM2165C1H101JA01D
4	Cap 680pF 50V 1% MLCC 0603	4	C9, C15, C29, C35	AVX	06035A681FAT2A
5	Cap 470uF 10V 20% aluminum SMD 6.3mm	2	C11, C30	Panasonic	EEE-FTA471XAP
6	Cap 100nF 50V X7R Ceramic SMD 0603	5	C55, C59, C60, C155, C156	Murata Electronics	GRM188R71H104K
7	Cap 10u 25V 20% Aluminum SMD 4.3x4.3	1	C61	United Chemi-Con	EMVA250ADA100MD55G
8	Diode 1N4148 150mA 75V 0603	4	D102, D103, D104, D105	Comchip Technology Corp.	CDSU4148
9	Conn Socket 6p Female Vert 0.1 Gold	5	J104, J105, J106, J107, J108	3M	929850-01-06-RB
10	Res 90R9 1% 0.1W Metal Film smt	4	R7, R12, R23, R32	Panasonic	ERJ-3EKF90R9V
11	Res 20k0 0%1 0.125W Thin Film 25ppm SMD 0805	4	R14, R17, R38, R41	Panasonic	ERA-6AEB203V
12	Res 330R 1% 0.1W Thick Film SMD 0603	1	R72	Bourns	CR0603-FX-3300ELF
13	Res 10k0 1% 0.1W Thick Film SMD 0603	2	R83, R84	Vishay Dale	CRCW06031002FRT1
14	6261N48-U	1	U1	THAT Corp	6261N48-U

Bill of Materials – 626x-DEMO Voltage Select Module

Item #	Description	Qty	Designator	Manufacturer	Mfr P/N
1	Conn Socket 8p Female Vert 0.1 Gold	1	J100	3M	929850-01-08-RB
2	Conn Socket 6p Female Vert 0.1 Gold	1	J103	3M	929850-01-06-RB

Appendix C. PCB Layout (1 of 4)

Mother Board, Component Screen

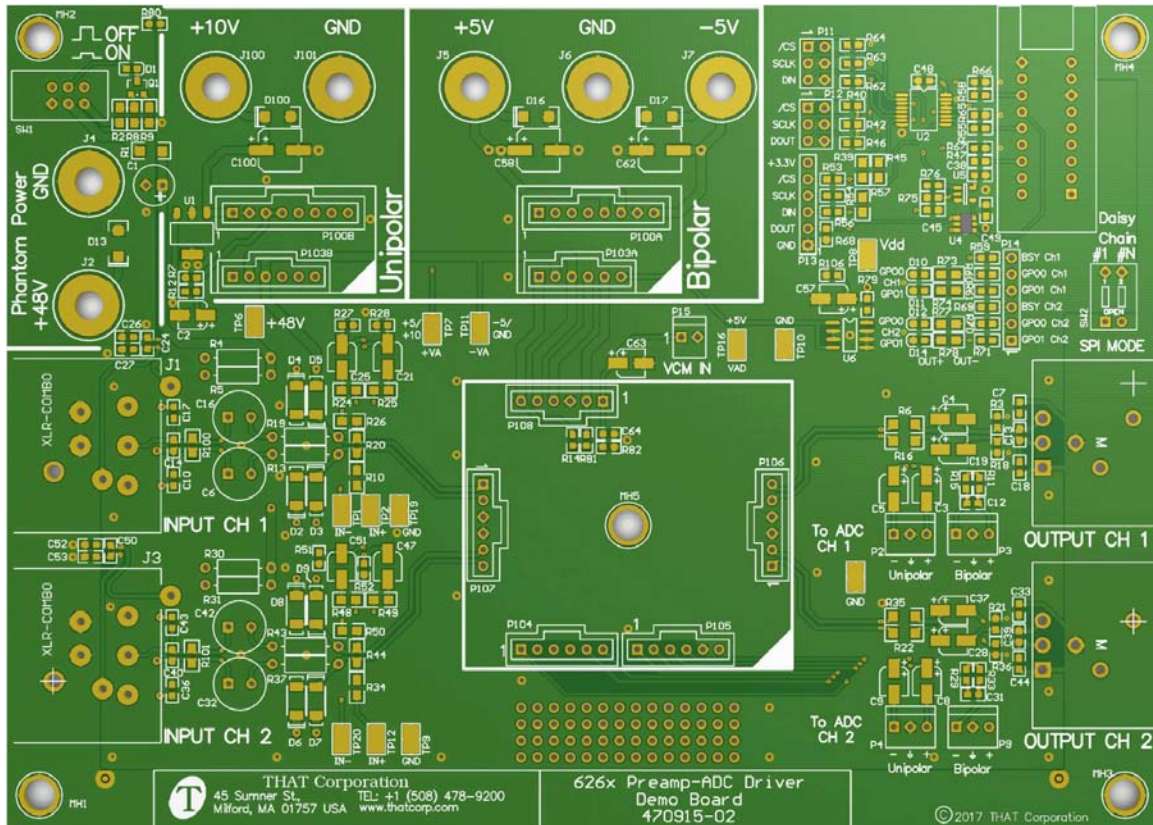

IC Module, Component Screen: (6261 shown)

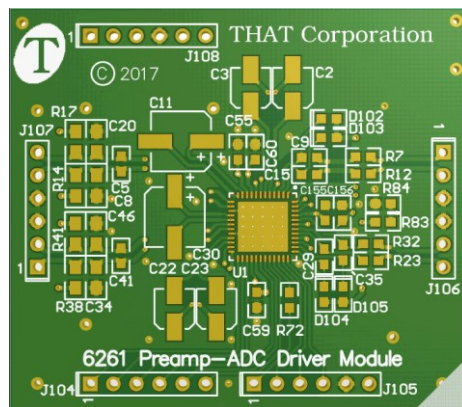

Voltage Select Module, Component Screen

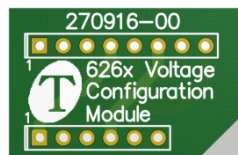

Appendix C. PCB Layout (2 of 4)

Mother Board, Top Layer

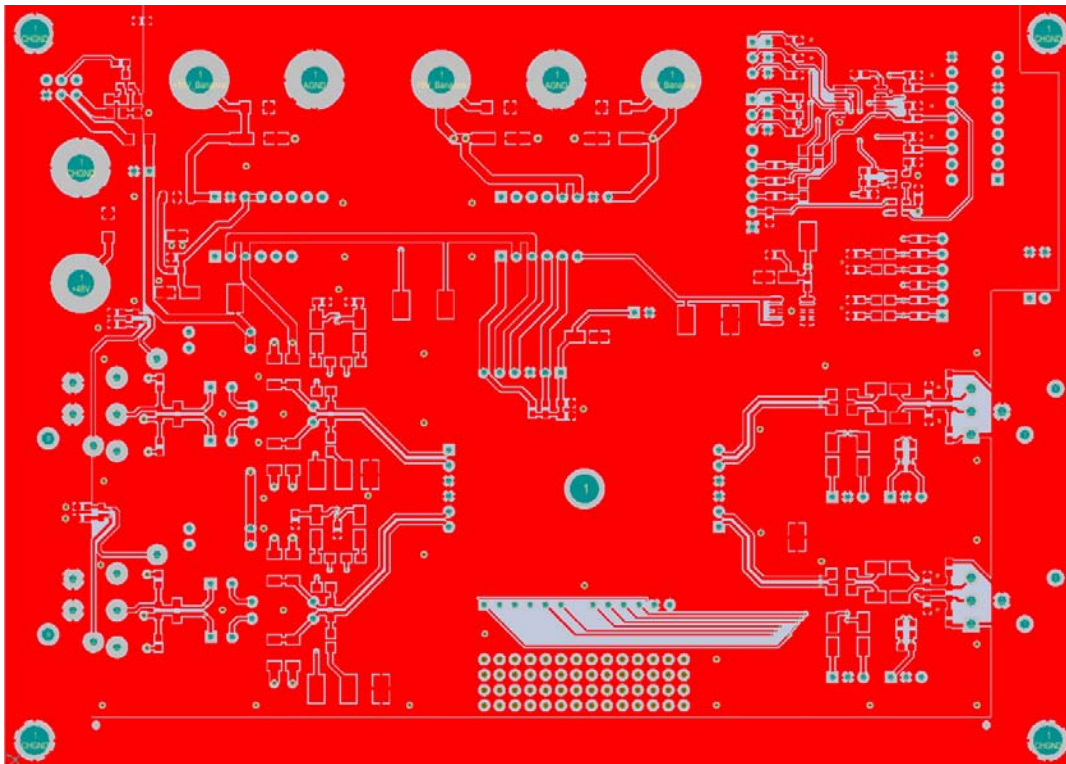

Mother Board, Power Layer

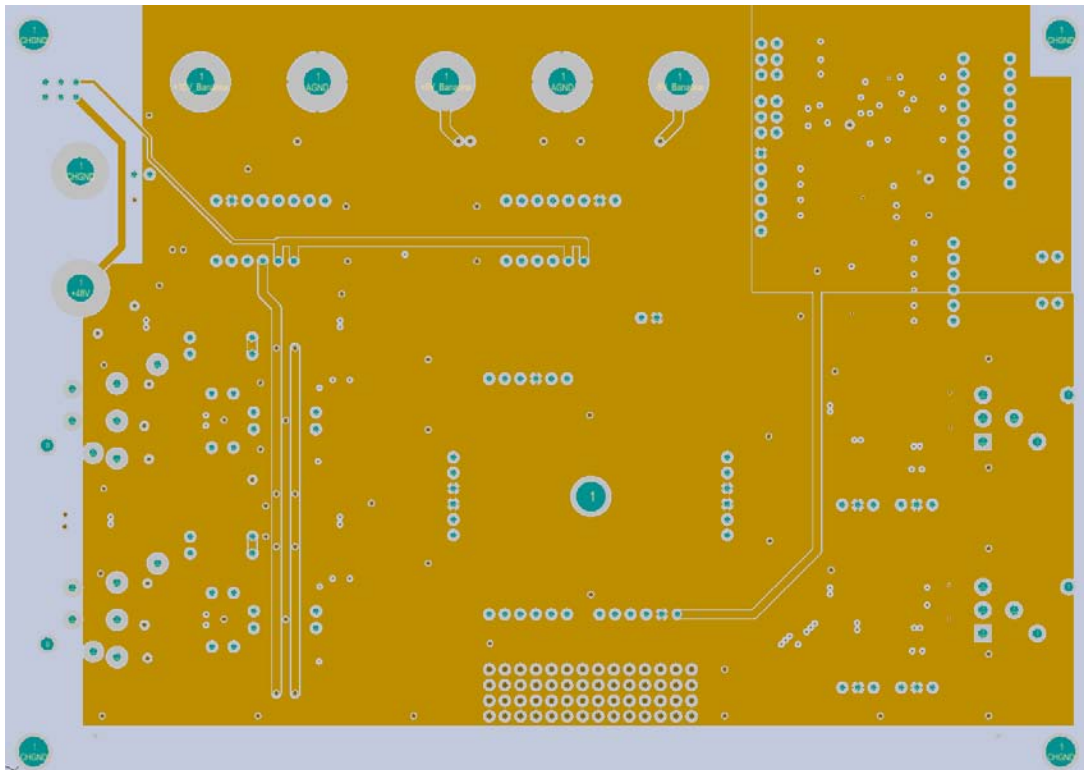

Appendix C. PCB Layout (3 of 4)

Mother Board, Ground Layer

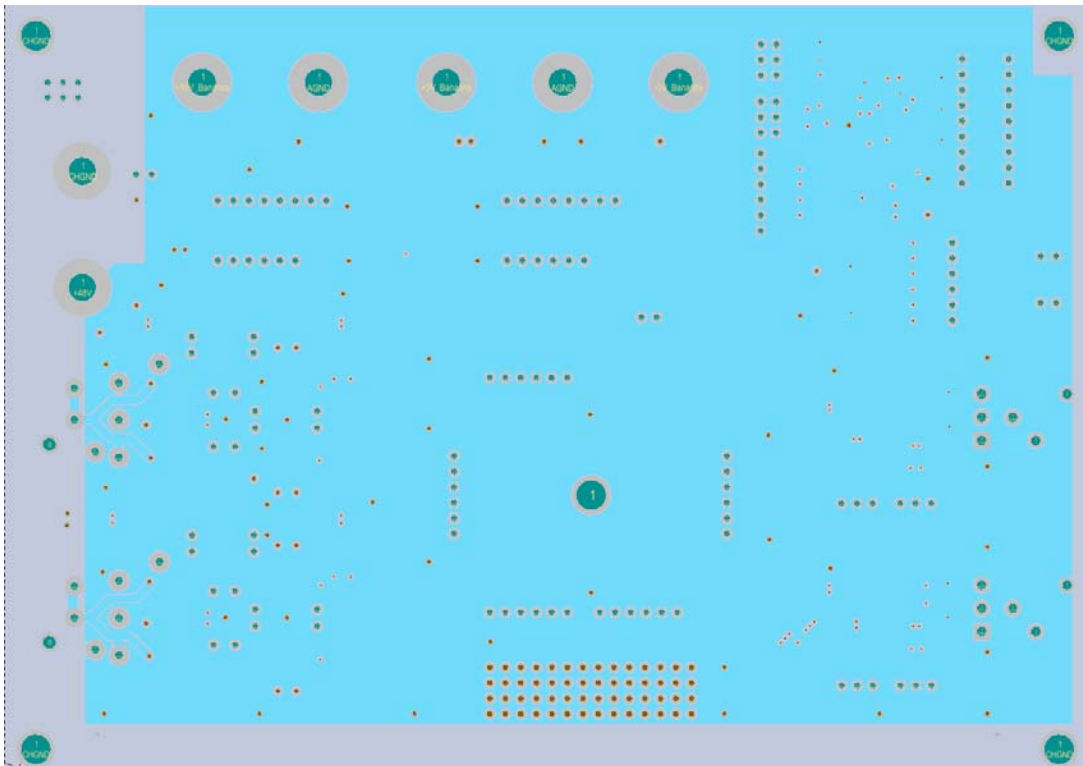

Mother Board, Bottom Layer

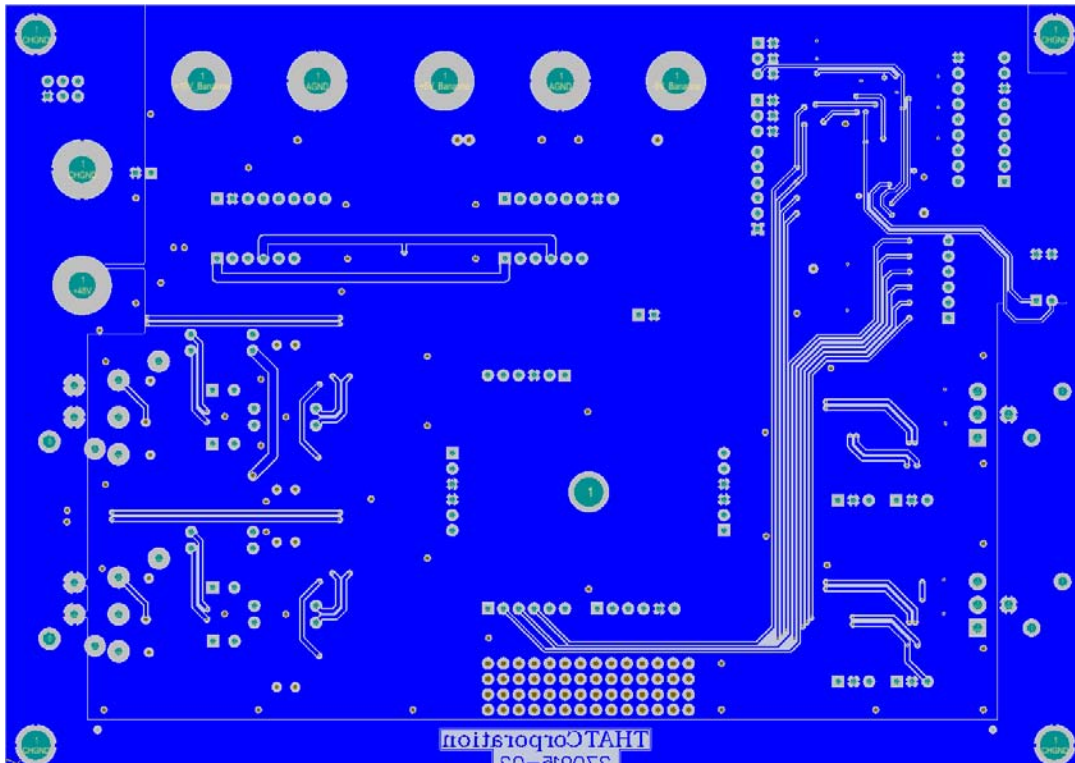

Appendix C. PCB Layout (4 of 4)

IC Module, Top Layer

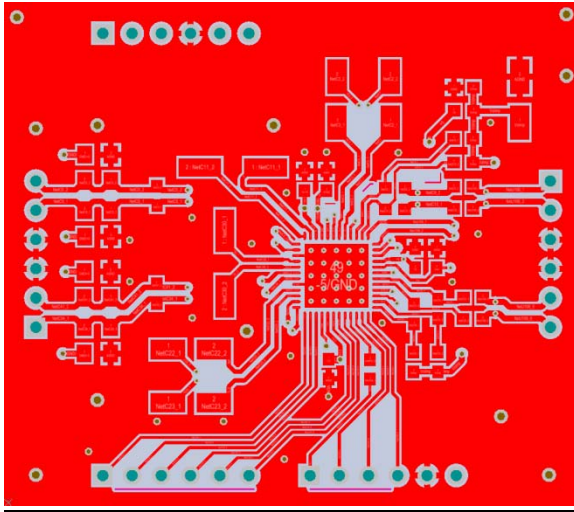

IC Module, Ground Layer

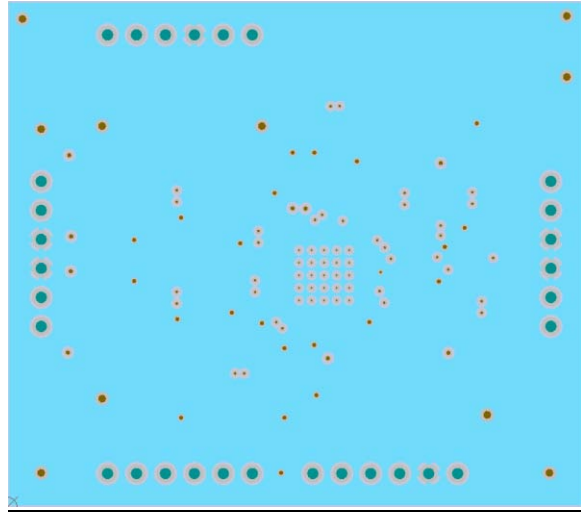

IC Module, Power Layer

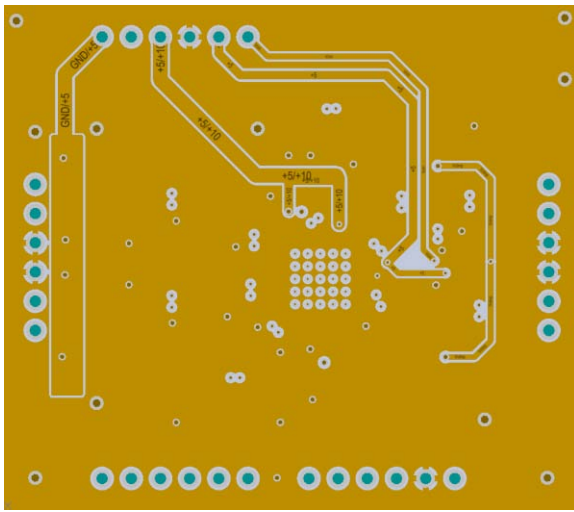

IC Module, Bottom Layer

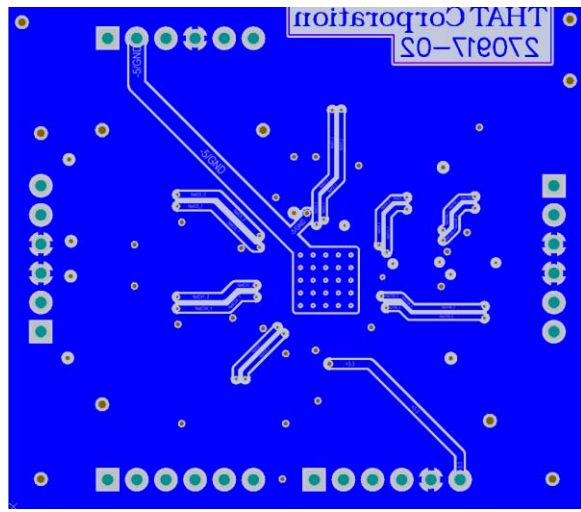

Revision History

Revision	ECO	Date	Changes	Page
00	—	06/14/18	Initial Release	—

Notes: